

Article number: 204040M1028A3X

Description: E+G levelling foot

GN 40-40-M10-28-A3-X

Note: X With female thread, External hexagon

Measures

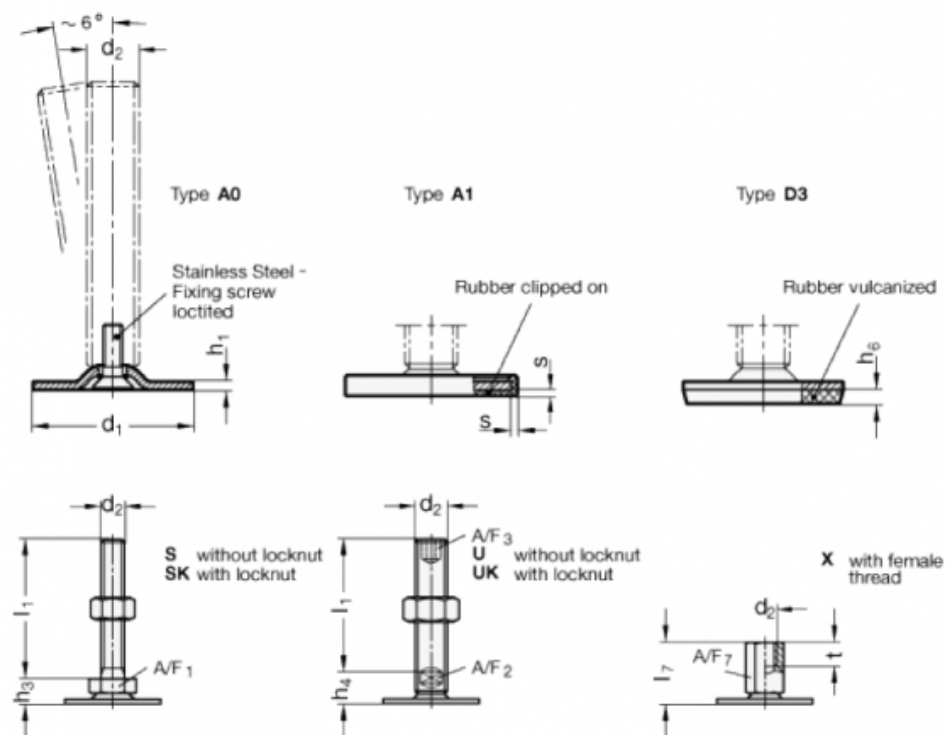

A/F7	= 14
d1	= 40
d2	= M10
h1	= 2
h6	= 3.5
l7	= 28
s	=
t	= 10